

KitVault Small DVR/NVR Enclosure

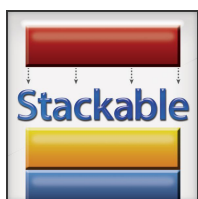

A Compact DVR/NVR Enclosure to keep CCTV footage safe, featuring a Removable Lid & Door for easy engineer access to the equipment inside

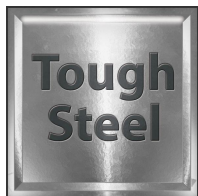

Key Features

- ✓ Tough steel build with attractive finish
- ✓ Handy bolt holes for wall mounting
- ✓ Handy fan slots for cooling equipment
- ✓ Lockable with a spare set of keys
- ✓ Multiple cable entries in/out
- ✓ Removable lid and door for easy setup
- ✓ Polycarbonate viewing window
- ✓ 3 other sizes also available
- ✓ Stackable design to add extra equipment
- ✓ Suits most 4 or 8 ch DVR/NVR models

Description

This compact CCTV equipment enclosure is ideal for smaller DVR and NVR units (usually with 1 hard drive fitted) to keep them secure from tampering by staff or even intruders. The latest data protection regulations call for personal data to be protected and this includes CCTV footage; in fact the CCTV Code of Practice states that all recorded CCTV images must be...

'securely stored, where only a limited number of authorised persons may have access to them'.

Great for smaller DVRs/NVRs but with enough space surrounding it to allow for the addition of up to 3 cooling fans (Code FAN012) to keep your CCTV equipment cool, especially handy in enclosed spaces.

Measuring just W430xD368xH150mm, the VAULT200 could be mounted to the wall sat on a shelf or desk without taking up too much room plus handy bolt holes mean the unit can be more permanently fixed in place doing away with the risk of theft of the entire unit.

Boasting a removable lid and door to make installing and setting up your recording device much easier, once it's up and running you can simply replace the lid back on the unit, click the door back into place and securely lock up the entire unit.

kitvault.com



Disclaimer

The technical specifications contained are given in good faith as being accurate but due to a continued program of improvement may change from time to time without notice. We apologise for any inconvenience due to changes of specification or errors and omissions within this document. Copyright 2021

KitVault Small DVR/NVR Enclosure



Unlike most enclosures on the market, this is really compact but has the added advantage of 3 fan slots too which is ideal if you're fitting your CCTV equipment in a hot area such as a retail or office environment.

Using a KitVault enclosure is even easier than rack mounting as you have clear access to the rear of the recorder making it easy to plug in your BNC and other leads thanks to the removable lid and door that can eventually be locked in place. There's no more trying to reach into the back of racks to find the lead you're looking for.

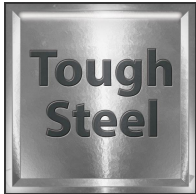

Each model features handy fixing holes that let you bolt the enclosure to a the wall behind it making it hard for an imposter to simply pick up it and walk out with it.

The units are designed to be stackable too with feet indentations on each to give extra stability. This is ideal for hiding away ancillary equipment such as distributors, power supplies, baluns and excess cabling and helps keep the installation neat and tidy.

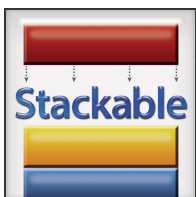

The Kitvault range includes 3 more sizes too!

The smaller VAULT100 is designed for smaller 4ch or 8ch DVR and NVR units and to keep it extra secure it is designed without a viewing panel or fan slots.

The medium version VAULT300 suits larger 8 or standard 16 channel DVR/NVR models and again has a tough polycarbonate viewing panel and 3 fan slots.



The largest model is VALUT400 and can accommodate the largest of DVR or NVR models often fitted with multiple hard drives such as the 2U rack sizes. It again has a tough polycarbonate viewing panel and 3 fan slots.

The complete KitVault range of enclosures comprises...

Extra Small - code VAULT100 (H)95mm x (W)384mm x (D)328mm

Small - code VAULT200 (H)150mm x (W)430mm x (D)368mm (*this model)

Medium - code VAULT300 (H)150mm x (W)490mm x (D)471mm

Large - code VALUT400 (H)150mm x (W)564mm x (D)597mm

kitvault.com



Disclaimer

The technical specifications contained are given in good faith as being accurate but due to a continued program of improvement may change from time to time without notice. We apologise for any inconvenience due to changes of specification or errors and omissions within this document. Copyright 2021

KitVault Small DVR/NVR Enclosure

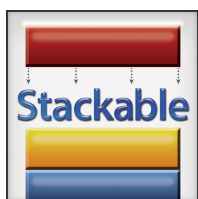
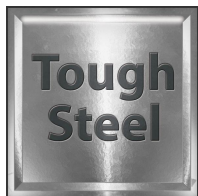

How It Works

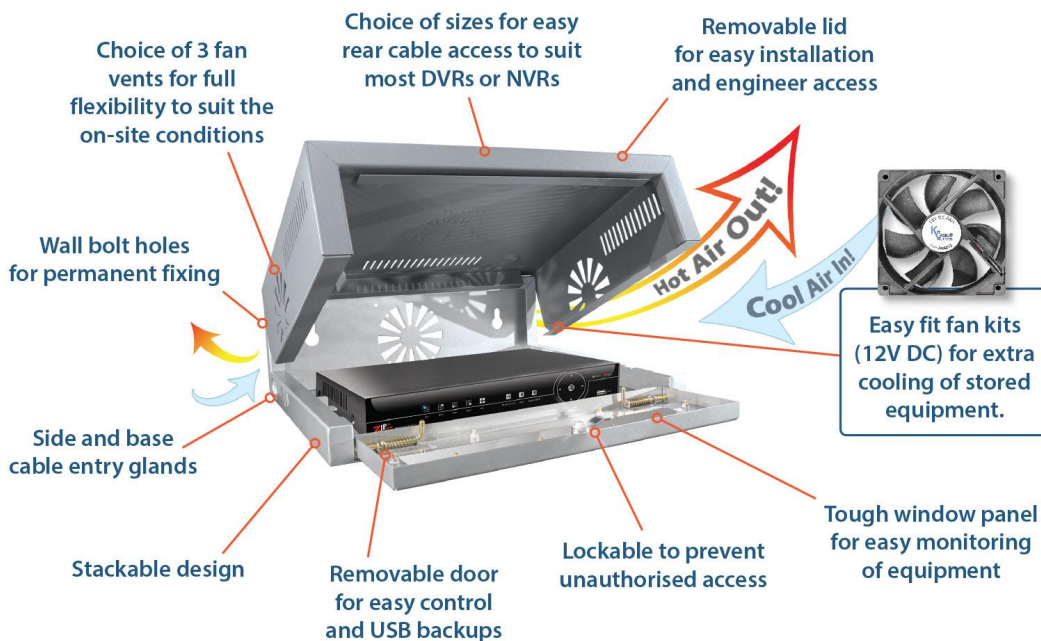

Door Removal

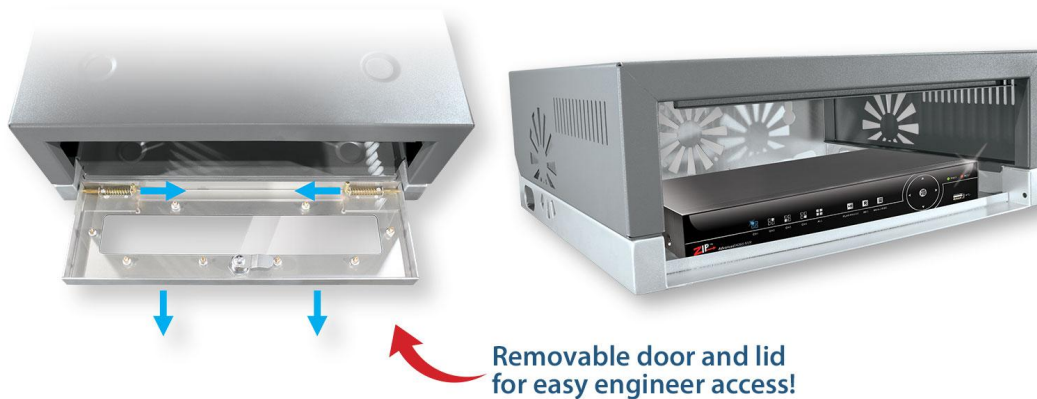

Dimensions

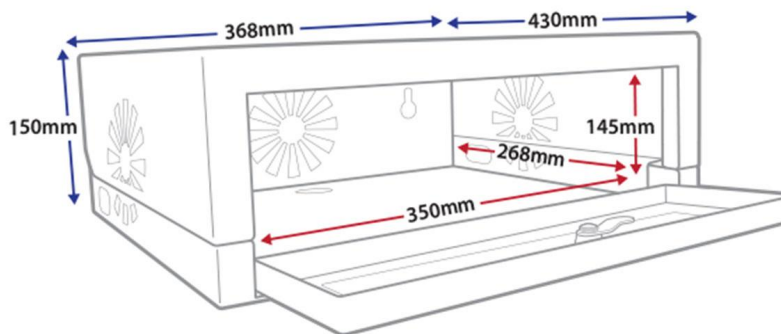

Best Fit

MEGA204 / MEGA208 / ZIP104

Allow for 30mm less width and/or depth when fitting fans

kitvault.com



Disclaimer

The technical specifications contained are given in good faith as being accurate but due to a continued program of improvement may change from time to time without notice. We apologise for any inconvenience due to changes of specification or errors and omissions within this document. Copyright 2021

KitVault Small DVR/NVR Enclosure

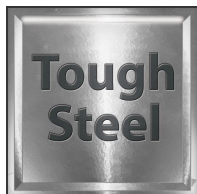

What's In The Box



KitVault DVR/NVR Enclosure

2 x Keys

Specification

Finish	Silver & Charcoal
Use	Internal Only
Cabling	Side & Base Entry Glands
Lockable	Hinged Front Door with Key Lock
Bolt Holes	Rear Bolt Holes
Build	1.5mm Steel
Mounting	Wall Mount
Max DVR/NVR Size	(H)145mm x (W)350mm x (D)268mm
Dimensions	(H)150mm x (W)430mm x (D)368mm

kitvault.com



Disclaimer

The technical specifications contained are given in good faith as being accurate but due to a continued program of improvement may change from time to time without notice. We apologise for any inconvenience due to changes of specification or errors and omissions within this document. Copyright 2021

Installer Details :